









Especificaciones Técnicas

RE-570 Silla Rewind

Características

- 1 Respaldo fabricado en inyección de polipropileno de alta resistencia reticulado para permitir circulación de aire, mayor confort y diseño ergonómico.
- 2 Asiento de polipropileno de alto impacto con terminación caída en cascada y concha inferior de asiento de polipropileno.
- 3 De acero tubular redondo de 4 patas calibre 16 terminada en pintura electrostática.

Acabados

Cuerpo						
	RJ	VD	BL	GO	AZ	NG
Base						
	Negro	Gris	Cromo			

Otros



8 Piezas



CATAS
EN 16139:2013

COSMOB

*Brazos y base tapíz opcional

Dimensiones

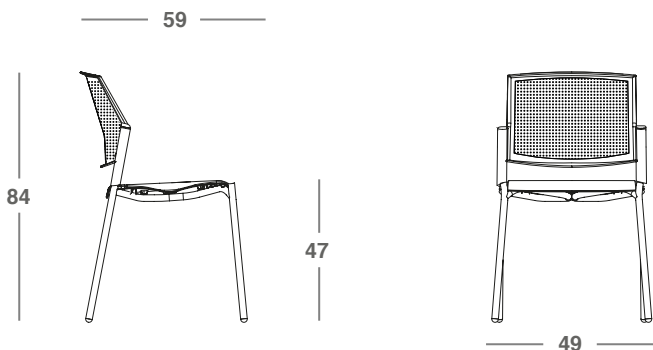

*Medidas en cm